















CICLI - CYCLES 











SOFT HARD CHEF **SOFT HARD** **MAN RIG**
+3°C **-18°C**



UTILITY **OPTIONS**

CAPACITY

 **+90°C/ +3°C** **40 KG**
 **+90°C/-18°C** **28 KG**

MAX CONDITION

 **32°C**  **60 UR%**

COMPANY
WITH QUALITY MANAGEMENT
SYSTEM CERTIFIED BY DNV
=ISO 9001: 2000=

10T 

Specifiche Tecniche - Specifications - Technische Daten - Données Techniques - Dato Técnicos

230 V / 50 Hz		400V/3N/50HZ	
Codice prodotto Item code no	Produkt-Kode-Nr. Nr. de code du produit	inox*rostfr.St s/s*inox	9AM010PI..
Lunghezza esterna Outside length	Aussenlänge Longueur extérieure	mm	790
Altezza Height	Höhe Hauteur	mm	1630
Profondità Depth	Tiefe Profondeur	mm	780
Capacità Capacity	Inhalt Capacité	GN 1/1 EN 600x400	10
Compressore Compressor	Kompressor Compresseur	DORIN	H200CS
Resa abbattimento Output chilling	Ergiebigkeit Schnellkühlung Rendement refroidissement	kg (t = 90') +90°C/+3°C	40
Resa surgelazione Output freezing	Ergiebigkeit Schockfrostung Rendement congelation	kg (t = 270') +90°C/-18°C	28
Potenza frigorifera Refrigeration power	Kalorienleistung Puissance frigorifique	W (-10°C/+45°C) W (-30°C/+45°C)	5798 2328
Fluido refrigerante Refrigerant fluid	Kältemittel Gas frigorifère	kg	R 404A 2.5
Centralina elettronica Electronic central unit	Elektronisches Steuergehäuse Centrale électronique		PCO-CHEF
Potenza assorbita Absorbed power	Leistungsaufnahme Puissance absorbée	W	2500
Rumorosità Noise	Lautstärke Bruit	db	65
Peso Weight	Gewicht Poids	Kg	-

ACCESSORIAMENTO-ACCESSORIES

N° 10

Teglie
Pastry Tray
600x400
passo/step 70 mm



N° 10

Bacincelle GN 1/1
Pan coolers GN 1/1
h max = 60 mm
passo/step 70 mm



N° 18

5 Litres Pans
Vaschette Gelato
165x360xh120
passo/step 140 mm



DIMENSIONI-DIMENSIONS

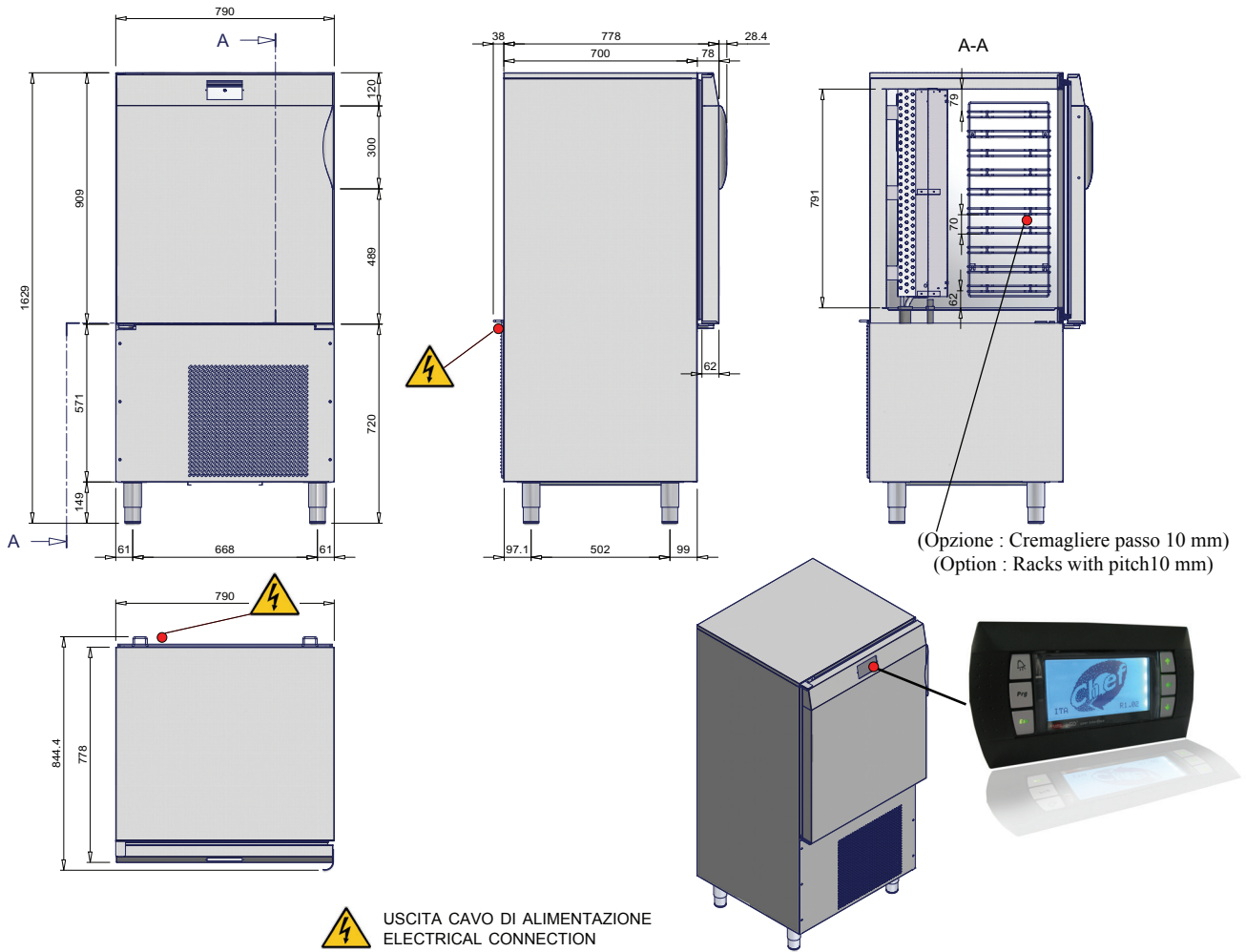

IMBALLO - PACKING

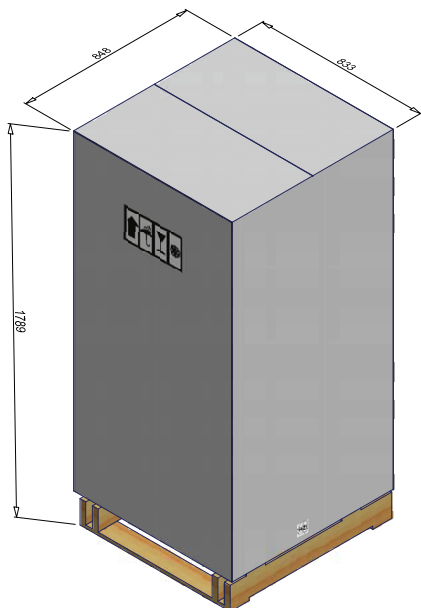

**MINIMA AREA INSTALLAZIONE
 MINIMUM INSTALLATION AREA**

